

Product Dimensions

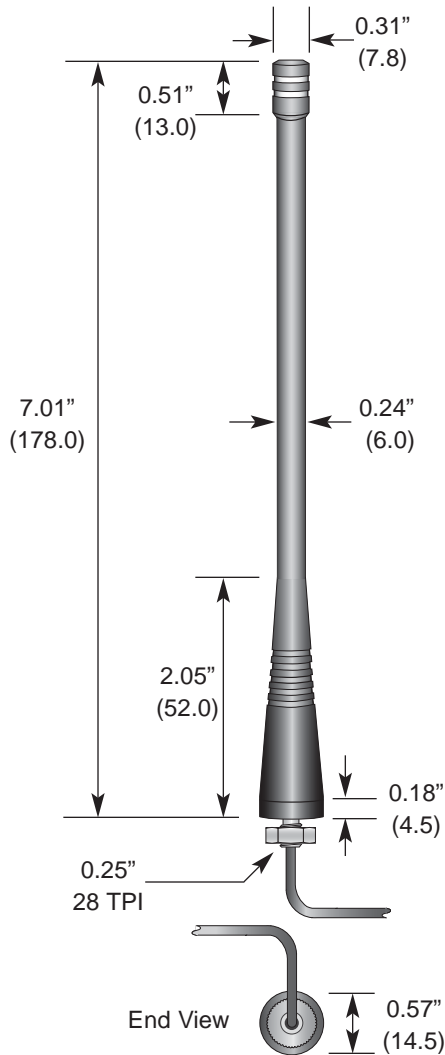

Description



Designed for permanent attachment, PW Series 1/4-wave whips give outstanding performance in a rugged and cost-effective package. The antenna is attached by placing its base through a 1/4" hole in the product and securing it with a nut or by threading it into a PEM-style insert. This method of attachment is highly secure and saves the cost of an antenna connector. The antenna is fed through the base with RG-174 coax cable, which may be soldered directly to the board or attached using a 50-ohm connector. Standard cable length is 8.5". Custom lengths and terminations are available by special order.

Features

- Low cost
- Outstanding performance
- Omni-directional pattern
- Wide bandwidth
- Flexible main shaft
- Rugged & weatherized
- Integral 8½-inch RG-174 coax cable
- Use with plastic* or metal enclosures

* Requires proximity ground plane

Electrical Specifications

- Center Freq. 418MHz
- Bandwidth 80MHz
- Wavelength 1/4-wave
- VSWR <1.9 typ. at center
- Impedance 50 ohms
- Connection Case-mount
- Cable 8½-inch RG-174 coax

Electrical specifications and plots measured on 4.00" x 4.00" reference ground plane

Ordering Information

- ANT-418-PW-QW

VSWR Graph

